

# Micro 100

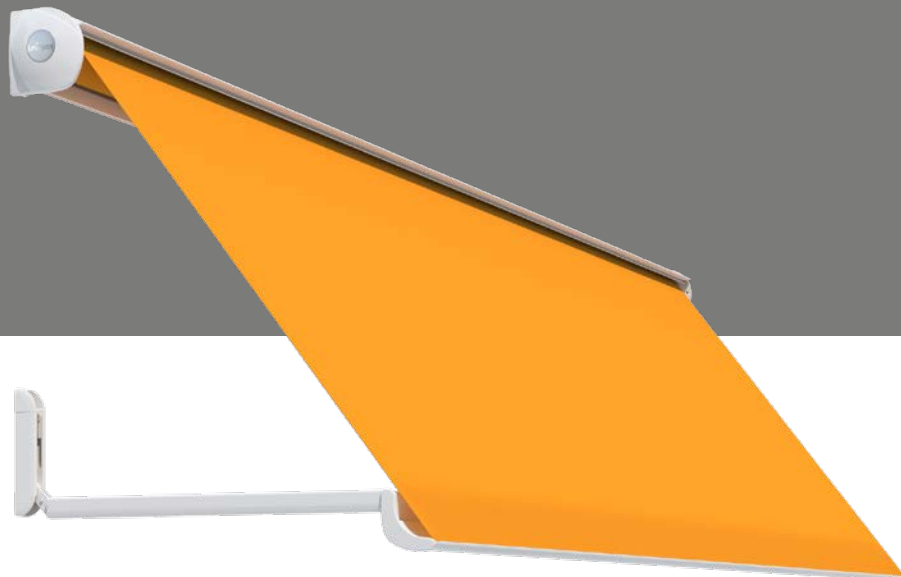

## Typen

*Types*

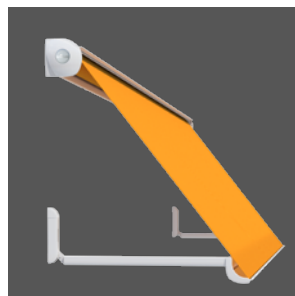

**90°**  
maximaler Neigungswinkel  
*maximum pitch angle*

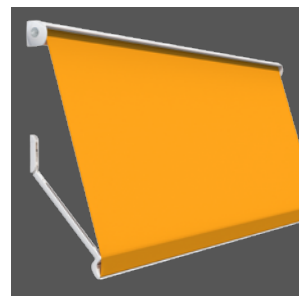

**135°**  
maximaler Neigungswinkel  
*maximum pitch angle*

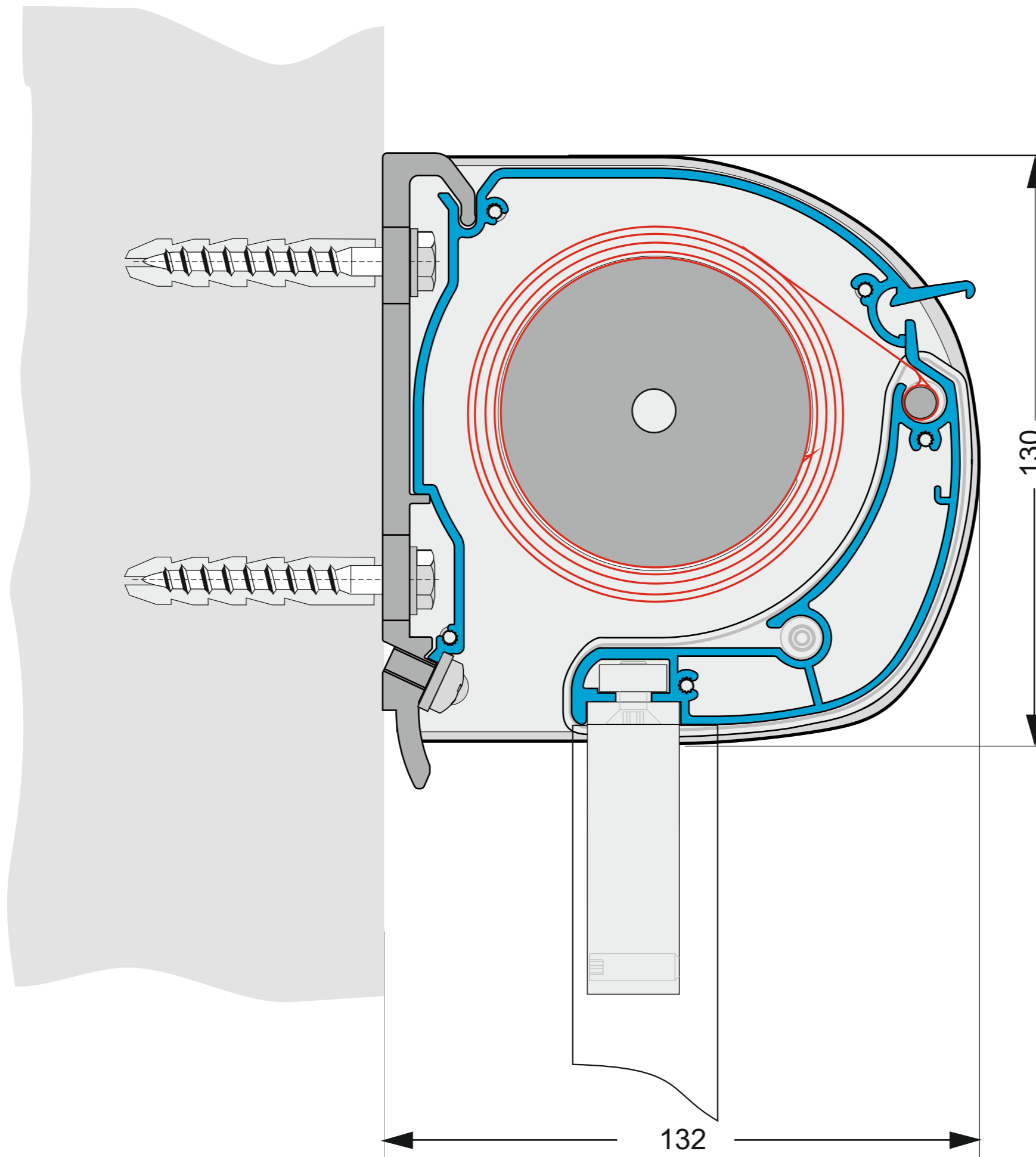

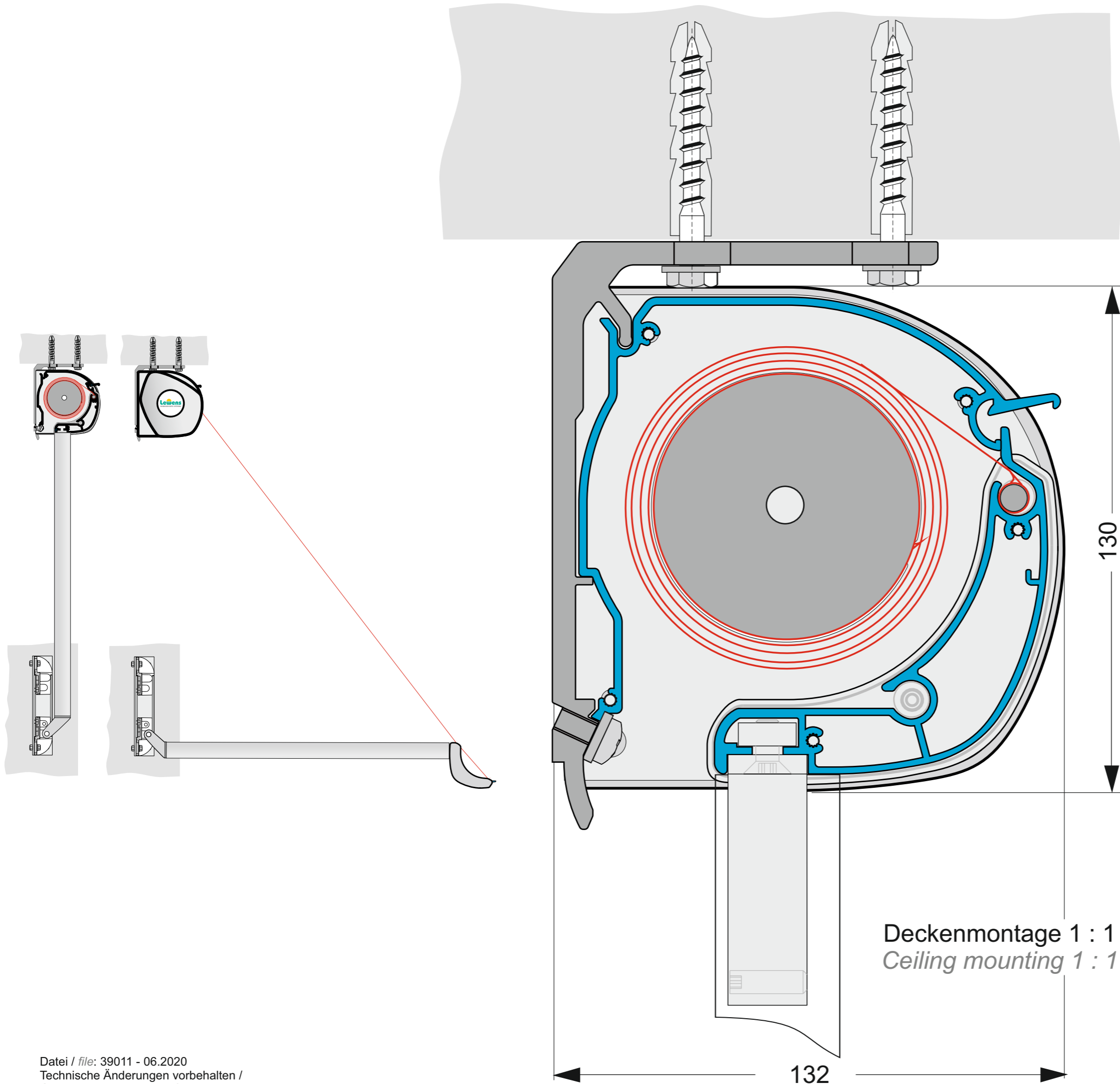

Deckenmontage  
*Ceiling mounting*

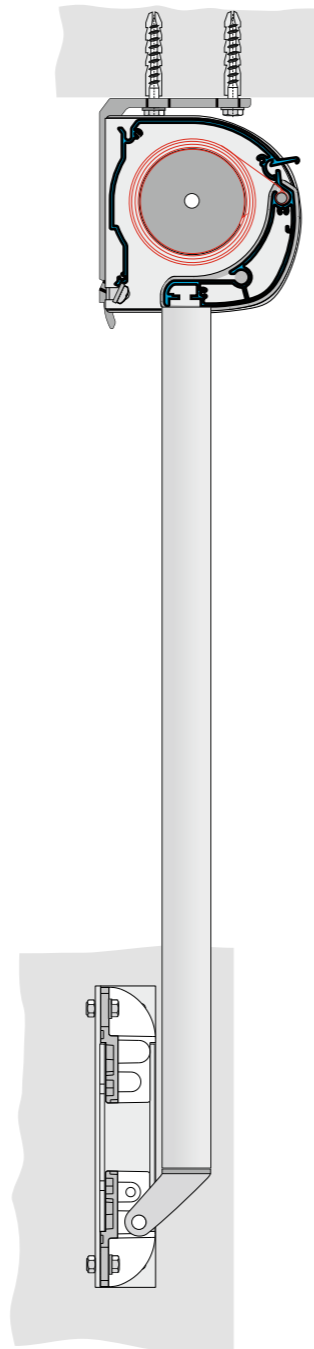

Wandmontage  
*Wall mounting*

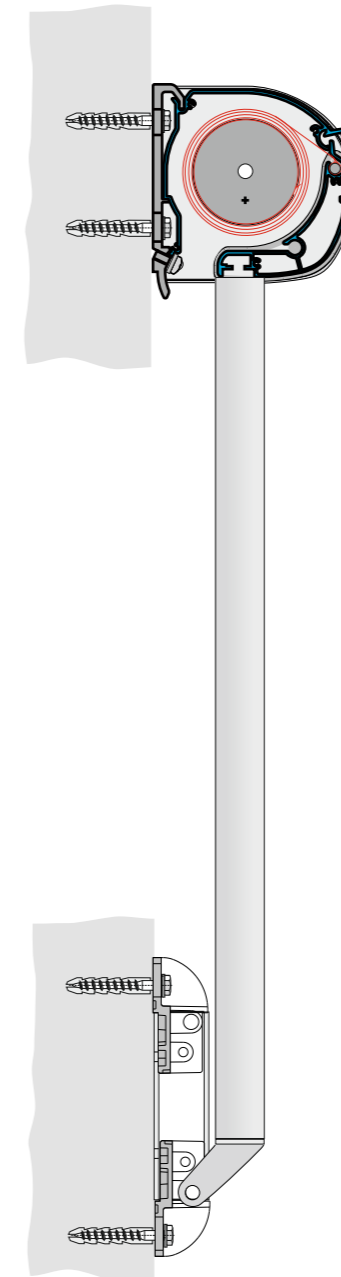

Teilleiste für Markise Micro 100 "DE" / Parts list for Micro 100 awning type "GB"

Pos.	Bestell.-Nr. / Order-No.	Bezeichnung "DE"	Description "GB"	Maße / Dimension	"DE"			"GB"		
					silber EG/EV1	grau RAL-9006	weiß RAL-9016	silber EG/EV1	grau RAL-9006	white RAL-9016
1	10923 L/R	Fallarm mit Feder inkl. Ausfallprofilhalter	Drop-arm w. spring	75-100-125-150-175 cm	x		x	x		x
2	41027 / 41028	Getriebeblende links/rechts	Covering tray for gearbox, left / right		x	-	x	x	-	x
4	41019	Seitenblech f.Dachprofil	Side plate f. Roof profile		-	x	x	-	x	x
5	41021 / 41022	Seitenkappe links/rechts	End cap for side plate, left / right		grau, weiß + schwarz			grey, white + black		
6	41005	Wandkonsole	Wall mounting bracket		-	x	x	-	x	x
6.1	41003 / 41004	Wandkonsole Innenbedienung, links /rechts	Wall mounting bracket f. operation from inside, left / right		-	x	x	-	x	x
-	41092	Deckenkonsole	Ceiling bracket		-	x	x	-	x	x
-	10631 / 10632	Ausgleichsplättchen Kunststoff	Plastic compensating shim	1 / 3 mm	-	x	-	-	x	-
-	41093	Nischenwinkel für Armhalter Getriebeseite	Recess angle bracket, gear unit side	40x100 mm	-	x	x	-	x	x
-	41094	Nischenwinkel für Armhalter Lagerseite	Recess angle bracket, bearing side	40x60 mm	-	x	x	-	x	x
7	41518	Antriebsbuchse f. 70 Tuchwelle,	Bearing bush with square pin for roller tube 70 x 1, only white		-	-	x	-	-	x
8	40505	Tuchwellenlagerbuchse f. 70 Tuchwelle,	Bearing bush with pin for roller tube 70 x 1, only white		-	-	x	-	-	x
9	417	Tuchwelle mit Nut, Rohr 70 x 1	Roller tube with spline groove 70 x 1	700 cm*	-	-	blank	-	-	bright
10	411	Ausfallprofil	Front profile	700 cm*	x	-	x	x	-	x
10.1	41006 / 41037	Abdeckkappe f. Ausfallprofil links/rechts	End cap for Front profile, left / right		grau, weiß + schwarz			grey, white + black		
11	410	Dach-/Rückwandprofil	Roof/rear wall profile	700 cm*	x	-	x	x	-	x
12	41927	Lewens Abdecksticker	Lewens sticker, round		x	-	-	x	-	-
-	41925	neutraler Abdecksticker	Neutral sticker, round		grau, weiß + schwarz			grey, white + black		
13	41036K	Schneckengetriebe 5,5:1, 105mm	Worm gear with housing 5,5:1, 105mm	Getriebe / gear = blank / bright      Öse / Eye=	grau, weiß + schwarz			grey, white + black		
-	41029	Schneckengetriebe 5,5:1 für Innenbedienung	Worm gear with housing 5,5:1 for inside operating	5,5 : 1	-	-	blank	-	-	bright
14	41928	Lagerblock weiß	Roller tube plate, white		-	-	x	-	-	x
16	108	Handkurbel	Crank	80-100-120-140-160-180-200-220-250-300 cm	-	x	x	-	x	x
-	41812	Gelenkkurbel 120 cm	Crank (foldable handle) 120 cm		-	x	-	-	x	-
-	41800	Halter für Gelenkkurbel	Crank-bracket		-	x	-	-	x	-
-	5001	Gelenklager / Wanddurchtritt 45°, verz.	Cardan joint/wall passage 45°, galvanised		-	-	blank	-	-	bright

\* = Maß Anlagenbreite (Effektivmaß=Anlagenbreite minus Abzugsmaß lt. Tabelle / \* =dimensions system width (actual dimension =system width minus deduction dimension as per table)

Technische Änderungen vorbehalten. / Subject to technical modifications.

