

Rolladen O. & M. Schröder OHG
Friederikastraße 12
44789 Bochum
Deutschland
Telefon: +49 (0)234 301077
Telefax: +49(0)234 331682
E-Mail: info@rollladen-schroeder.de
Internet: www.rollladen-schroeder.de

Konsolentypen, Konsolenzahl | *Installation: bracket types, number of brackets*

Befestigung

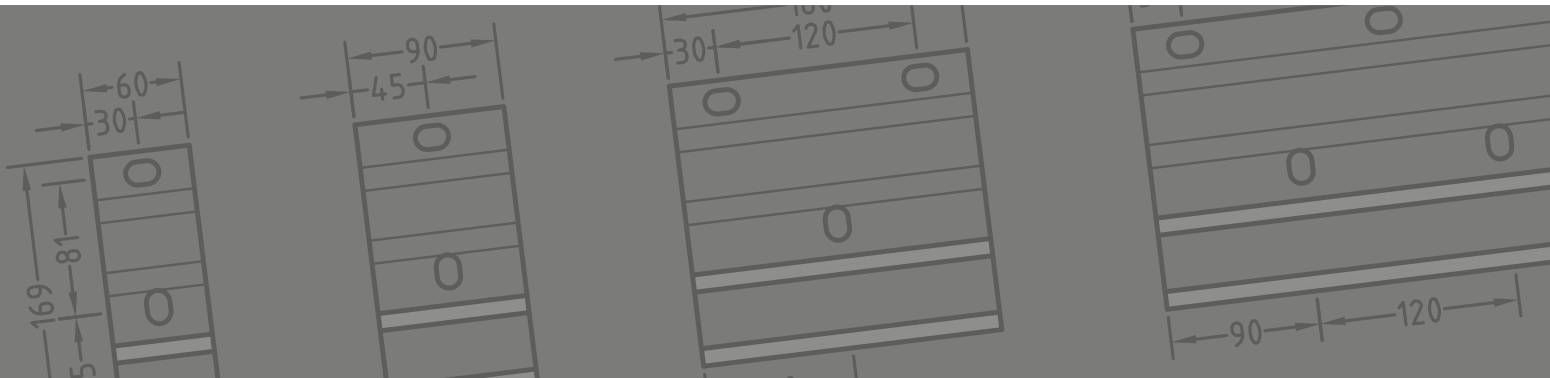

Economy-/ Family-Wandkonsolen / wall brackets

Typ/Breite (mm)

60

90

180

300

Type/width (mm)

Lochmaße

Hole dimensions

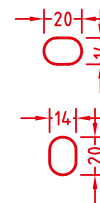
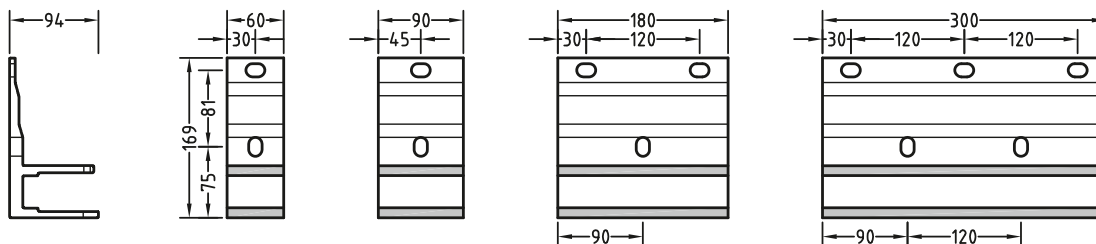

Wandkonsole, bepulvert in Gestellfarbe (bei Silber immer RAL 9006)

Wall bracket, powder coated in frame colour (in silver always RAL 9006)

Economy-/ Family-Universalkonsolen / universal brackets

Typ/Breite (mm)

60

90

180

Type/width (mm)

für Economy Typ Regendach
oder Deckenmontage
for Economy Rain cover type
or ceiling mounting

Universalkonsole für Family, Economy

Universal bracket for Family, Economy

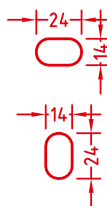
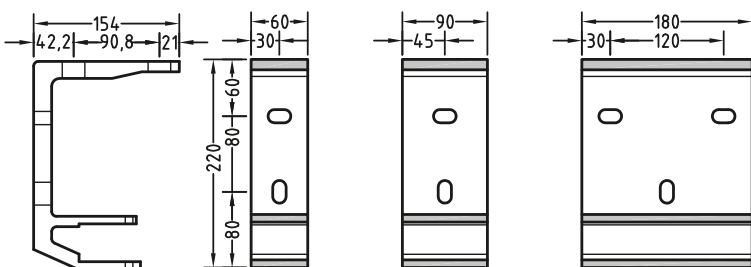

Economy-Dachsparrenhalter / rafter brackets

für Universalkonsole, Ausführung in Stahl

for Universal bracket, steel

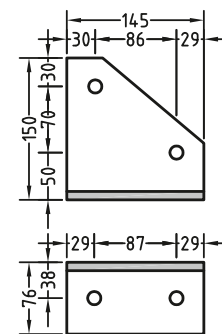

Universalkonsole, bepulvert in Gestellfarbe
(bei Silber immer RAL 9006)

Universal bracket, powder coated in frame colour
(in silver always RAL 9006)

Stahl, verzinkt, pulverbeschichtet,
Farbe Silber RAL 9006 oder Weiss RAL 9016

Steel, galvanized, powder coated
Colour silver RAL 9006 or white RAL 9016

Economy-/ Family-Dübelabdeckung (Thermax) / wall plug cover (Thermax)

Typ/Breite (mm)

110

200

320

Type/width (mm)

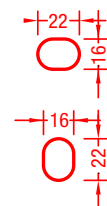
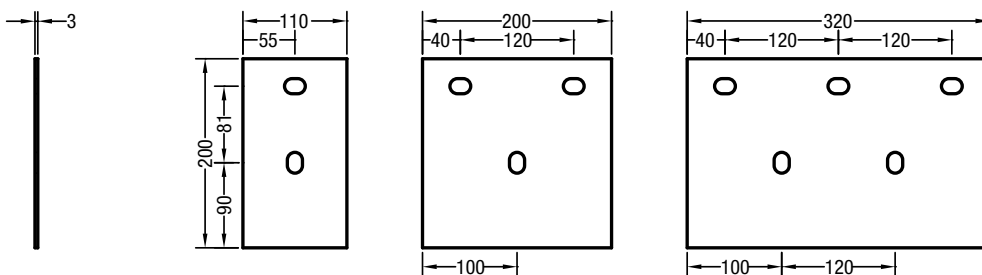

Dübelabdeckung, bepulvert in Gestellfarbe (bei Silber immer RAL 9006)

Wall plug cover, powder coated in frame colour (in silver always RAL 9006)

Befestigung / Installation

Trentino Mini-Wandkonsolen / wall brackets

Typ/Breite (mm)

90

180

300

Type/width (mm)

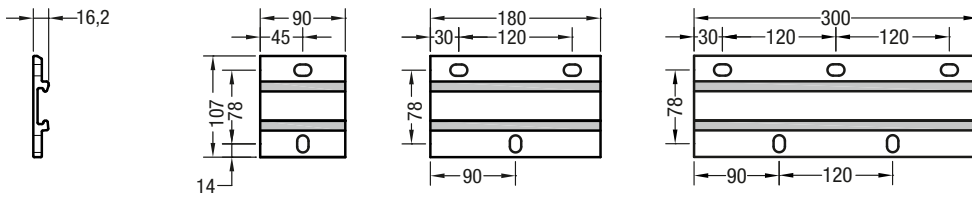

Lochmaße

Hole dimensions

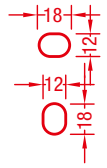

Wandkonsole, bepulvert in Gestellfarbe (bei Silber immer RAL 9006)

Wall bracket, powder coated in frame colour (in silver always RAL 9006)

Trentino Mini-Wandkonsole mit Dübelabdeckung (Thermax) / wall bracket with wall plug cover (Thermax)

Typ/Breite (mm)

180

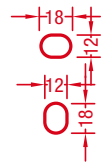
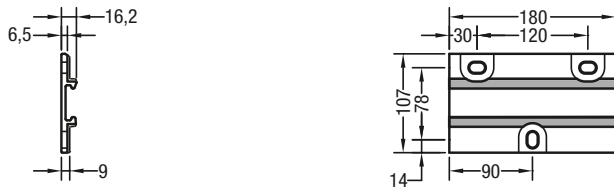

Wandkonsole mit Dübelabdeckung, bepulvert in Gestellfarbe (bei Silber immer RAL 9006)

Wall bracket with wall plug cover, powder coated in frame colour (in silver always RAL 9006)

Trentino Mini-Deckenwinkel / ceiling angle bracket

Typ / Breite (mm)

90

180

Type/width (mm)

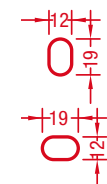
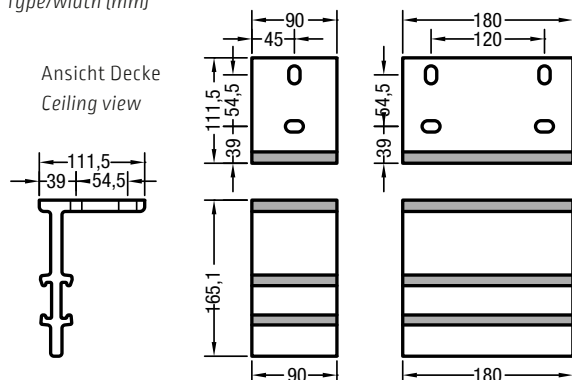

Deckenwinkel inkl. Verbindungsschrauben für Wand / Decke, bepulvert in Gestellfarbe (bei Silber immer RAL 9006)

Ceiling angle bracket including connector screws for wall/ceiling, powder coated in frame colour (in silver always RAL 9006)

Trentino-Wandkonsolen (verstellbar) / wall brackets (adjustable)

Typ/Breite (mm)

90

180

300

Type/width (mm)

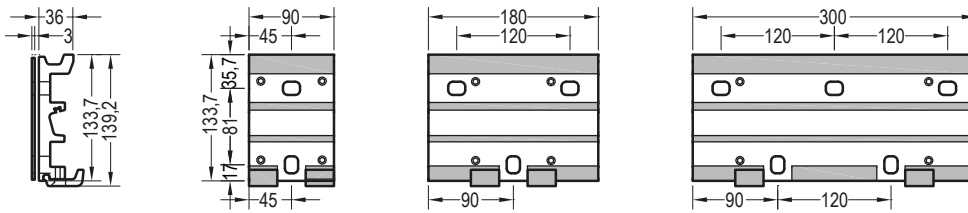

Lochmaße
Hole dimensions

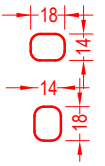

Wandkonsole, bepulvert in Gestellfarbe (bei Silber immer RAL 9006)

Wall bracket, powder coated in frame colour (in silver always RAL 9006)

Trentino-/ Toscana Mini-Dübelabdeckung (Thermax) / wall plug cover (Thermax)

Typ/Breite (mm)

110

200

320

Type/width (mm)

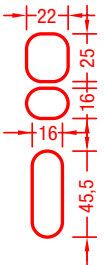
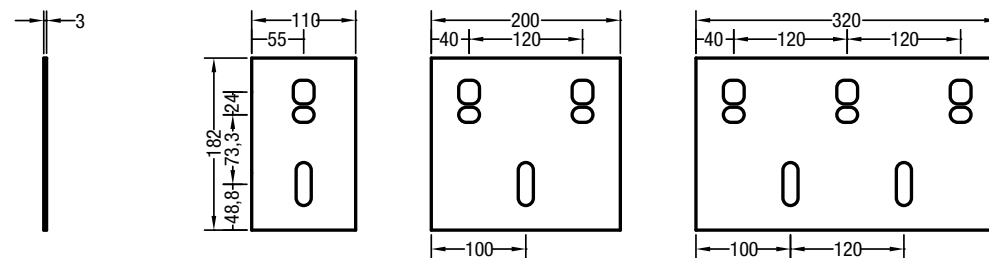

Dübelabdeckung, bepulvert in Gestellfarbe (bei Silber immer RAL 9006)

Wall plug cover, powder coated in frame colour (in silver always RAL 9006)

Toscana Mini-Konsolen / brackets

Typ/Breite (mm)

70

180

300

Type/width (mm)

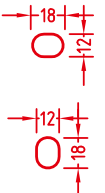
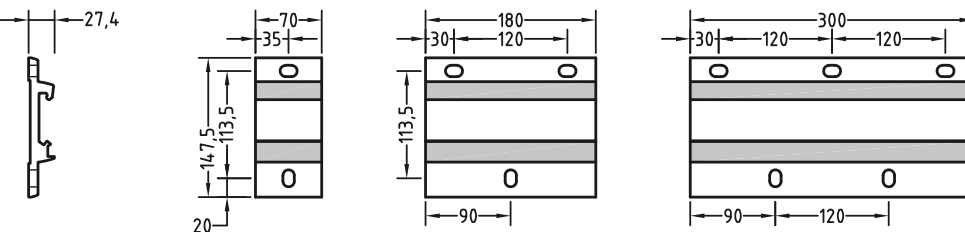

Wand- und Deckenkonsolle, bepulvert in Gestellfarbe (bei Silber immer RAL 9006)

Wall and ceiling bracket, powder coated in frame colour (in silver always RAL 9006)

Toscana Mini-Nischenwinkel

/ recess angle bracket

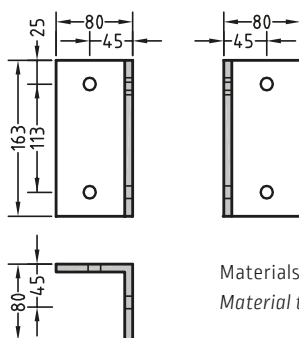

Materialstärke: 8 mm
Material thickness: 8 mm



Toscana-Nischenwinkel

/ recess angle bracket

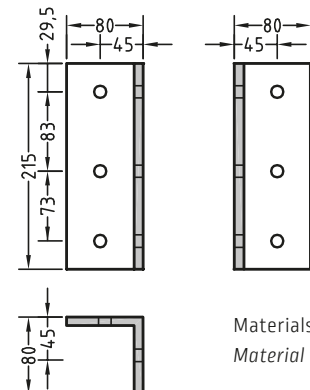

Materialstärke: 8 mm
Material thickness: 8 mm



Nischenwinkel, bepulvert in Gestellfarbe (bei Silber immer RAL 9006) / Recess angle bracket, powder coated in frame colour (in silver always RAL 9006)

Befestigung / Installation

Toscana-Konsolen

Typ/Breite (mm)

70

180

300

Type/width (mm)

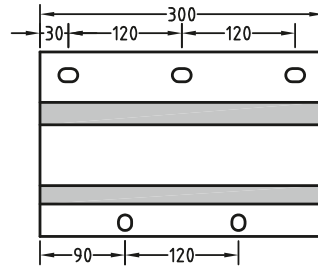
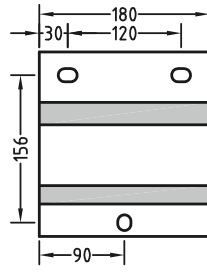
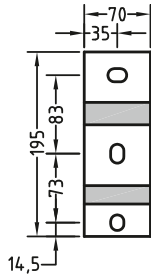
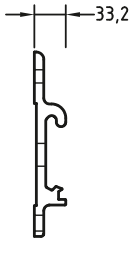

Lochmaße

Hole dimensions

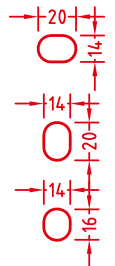

Wand- und Deckenkonsole, bepulvert in Gestellfarbe (bei Silber immer RAL 9006)

Wall and ceiling bracket, powder coated in frame colour (in silver always RAL 9006)

Toscana Grande-Konsolen / brackets

Typ/Breite (mm)

90

180

300

Type/width (mm)

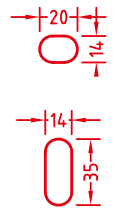
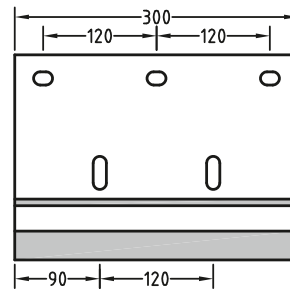
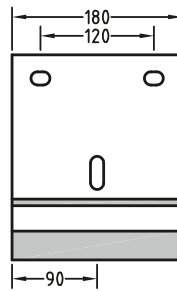
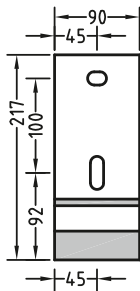
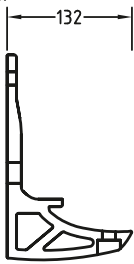

Wandkonsole inkl. Gehäusehalter am Gehäuse, bepulvert in Gestellfarbe (bei Silber immer RAL 9006)

Wall bracket, incl. case mount at the cassette, powder coated in frame colour (in silver always RAL 9006)

Innenbefestigung + Gehäusehalter für 3. Konsole [extra]

Internal mounting + casing bracket for 3rd bracket [extra]

Toscana / Toscana Grande-Dübelabdeckung (Thermax) / wall plug cover (Thermax)

Typ/Breite (mm)

110

200

320

Type/width (mm)

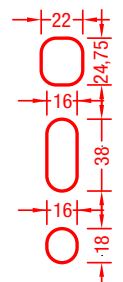
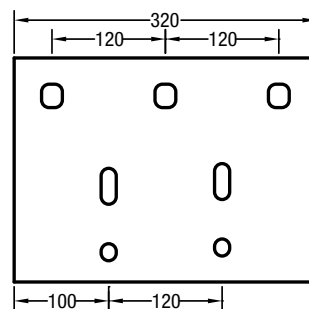
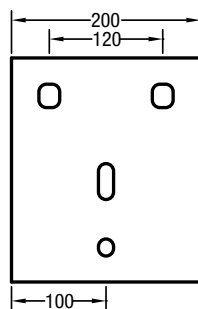
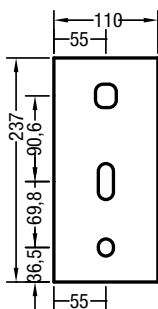

Dübelabdeckung, bepulvert in Gestellfarbe (bei Silber immer RAL 9006) / *Wall plug cover, powder coated in frame colour (in silver always RAL 9006)*

Montageplatte (für 90er Konsolen außer Trentino Mini) / Mounting plate (for 90 brackets except Trentino Mini)

Typ/Breite (mm)

A 300

B 500

Type/width (mm)

Lochmaße

Hole dimensions

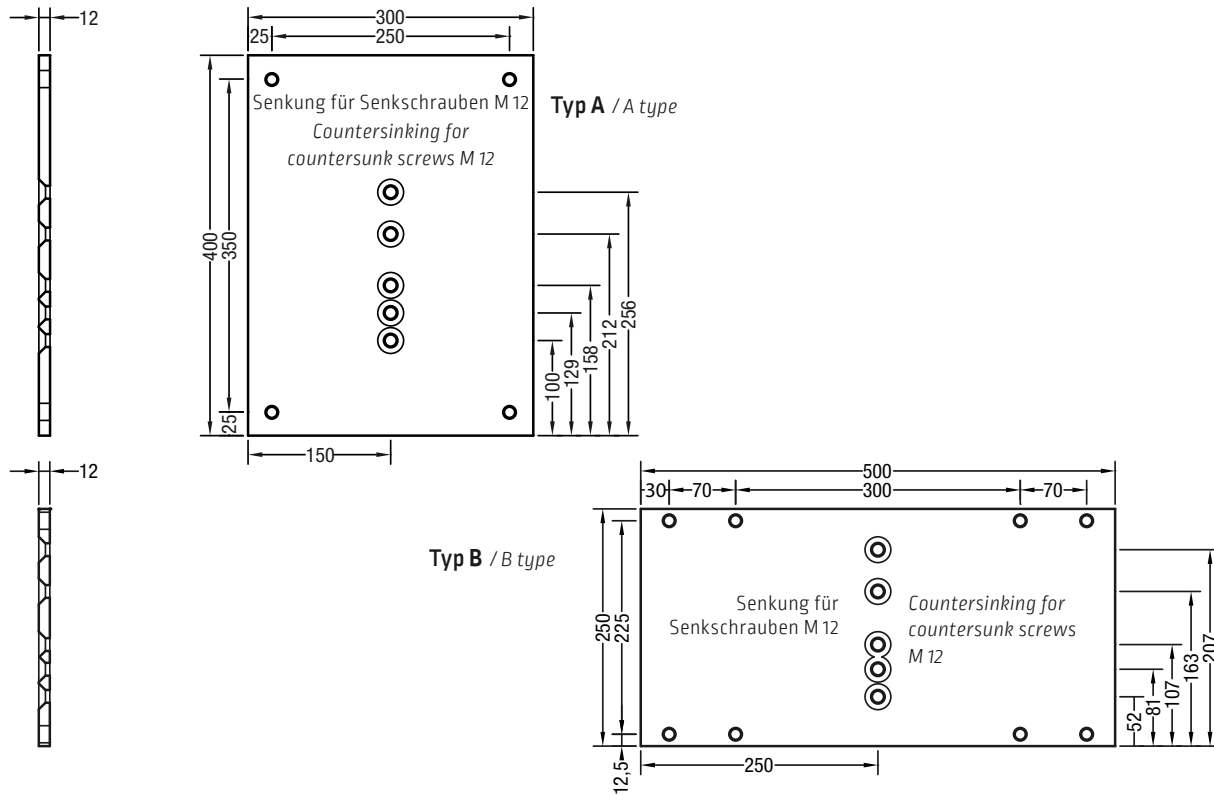

Montageplatte, bepulvert in Gestellfarbe (bei silber immer RAL 9006) / **Mounting plate**, powder coated in frame colour (in silver always RAL 9006)

Abstand-Montageplatte (für 90er Konsolen außer Trentino Mini) / Spacer mounting plate (for 90 brackets except Trentino Mini)

Typ/Abstand (mm)

165

Type/width (mm)

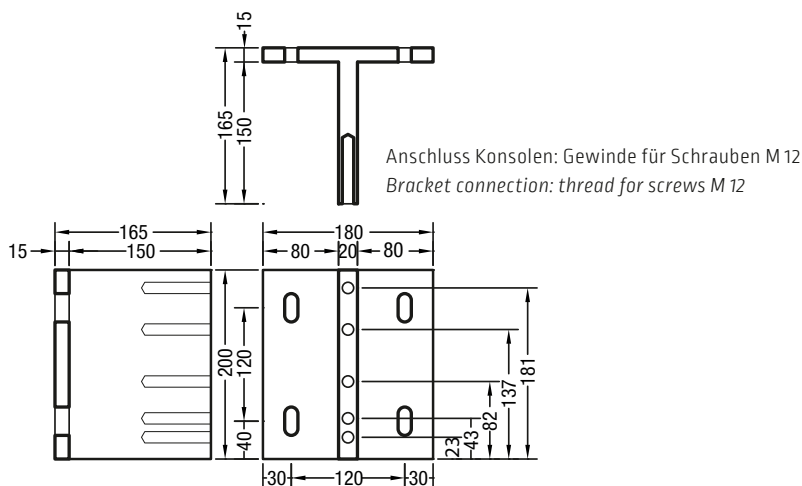

Abstand-Montageplatte, bepulvert in Gestellfarbe (bei silber immer RAL 9006)

Spacer mounting plate, powder coated in frame colour (in silver always RAL 9006)

Befestigung / Installation

Dachsparrenhalter Ausführung in Aluminium / Rafter brackets – aluminium

Typ / Type

Lochmaße

Hole dimensions

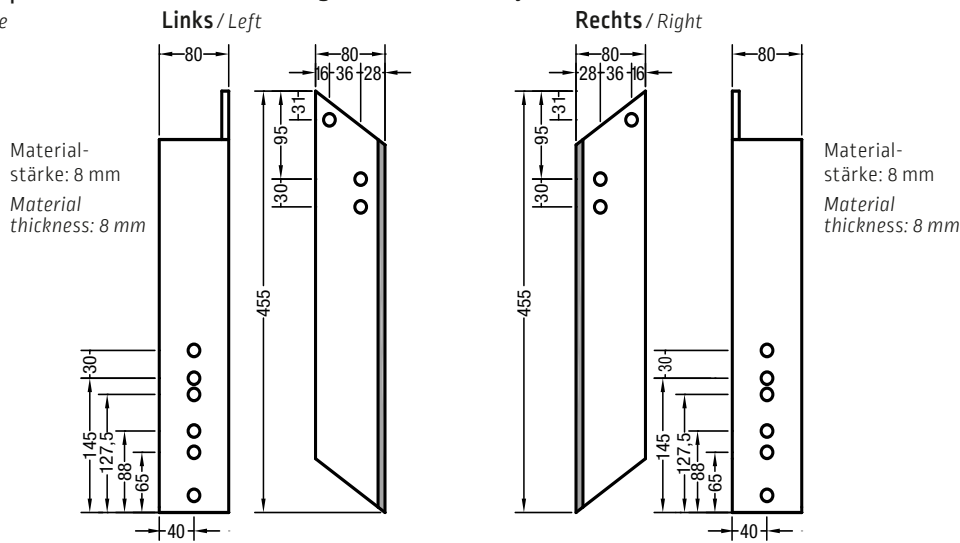

Dachsparrenhalter, lange Ausführung, inkl. Verbindungsschrauben, bepulvert in Gestellfarbe (bei Silber immer RAL 9006)

Rafter bracket, long version, including connector screws, powder coated in frame colour (in silver always RAL 9006)

Montageplatten für Dachsparrenhalter

/ Mounting plate for rafter bracket

Für alle Gelenkarmmarkisen / For all folding arm awnings

Materialstärke: 8 mm
Material thickness: 8 mm

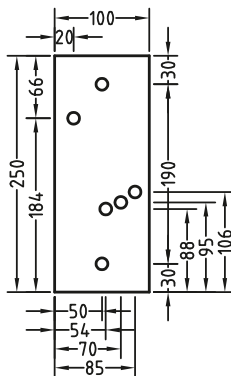

Unterlegplatten für Wandkonsole, Kunststoff, weiß:

/ Spacers for wall brackets, plastic, white:

60er für Economy, 10 mm stark
/ 60 mm for Economy, 10 mm thick

70er für Toscana, 10/20 mm stark
/ 70 mm for Toscana, 10/20 mm thick

90er für entspr. Modelle, 10/20 mm stark
/ 90 mm for appropriate models 10/20 mm thick

Unterlegkeil, Kunststoff

/ Wedge, plastic

Ausgleichsplättchen, Kunststoff, 1 mm/3 mm

/ Shim, plastic, 1 mm/3 mm

Distanzrohr, Kunststoff, Ø 48 mm außen,

Ø 18 mm innen, Stecksystem 10/50/100 mm

/ Spacer tube, plastic, Ø 48 mm outside,

Ø 18 mm inside, plug system 10 / 50 / 100 mm

Montageplatte, bepulvert in Gestellfarbe (bei Silber immer RAL 9006)

Mounting plate, powder coated in frame colour (in silver always RAL 9006)

Deckenwinkel / Ceiling angle bracket

Typ / Breite (mm)

Lochmaße

Hole dimensions

Type/width (mm)

Ansicht Decke
Ceiling view

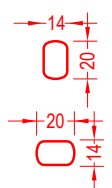
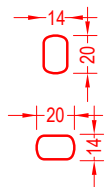
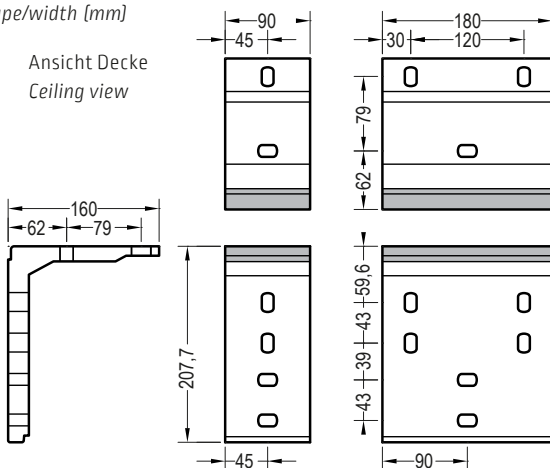

Deckenwinkel inkl. Verbindungsschrauben für Wand / Decke, bepulvert in Gestellfarbe (bei Silber immer RAL 9006)

Ceiling angle bracket, including connector screws for wall / ceiling, powder coated in frame colour (in silver always RAL 9006)

Ancona Bestellmaße in cm / ordering dimensions in cm

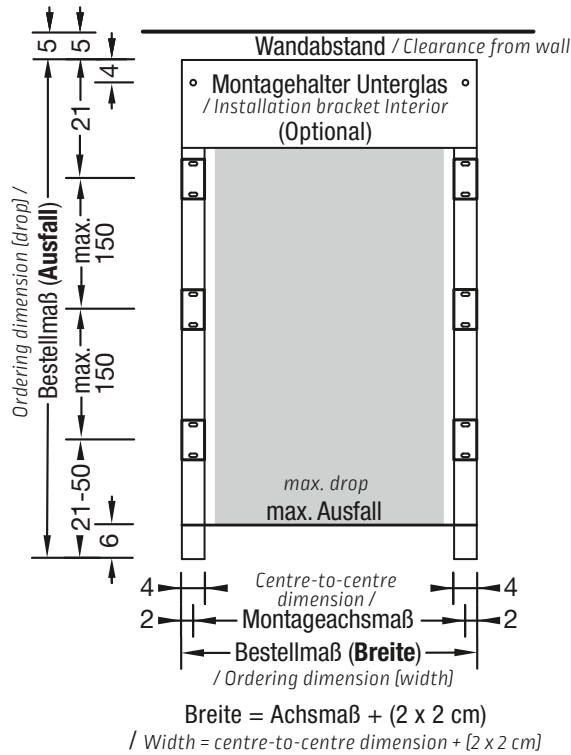

Schienehalter / Rail holder

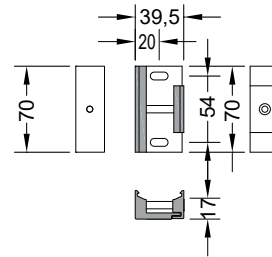

Lochmaße Hole dimensions

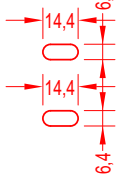

Anzahl Befestigungen / Number of attachments

Breite / Width [cm]	Ausfall / Drop [cm]						
150	200	250	300	350	400	450	
up to bis 600	4	6	6	6	8	8	8

Ancona Aufglas-Montage / Roof-mounted

Montagefuß (Standard 10er für Aufglas)
/ Mounting foot (standard size 10 for roof-mounted)

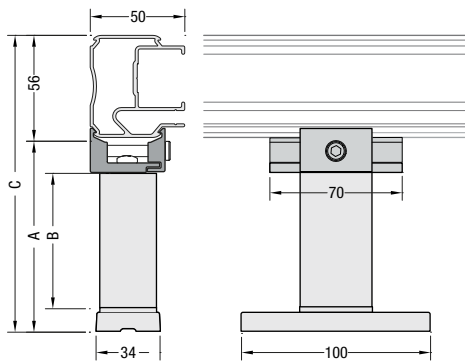

Montagefuß	10er	13er	18er
A	101	126	176
B	72	97	147
C	157	182	232

Mounting foot

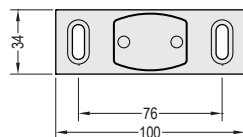

Doppelaufnahme
/ Double track holder

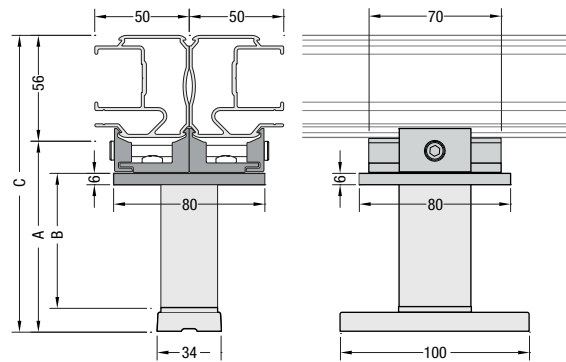

Doppelaufnahme	10er	13er	18er
A	101	126	176
B	72	97	147
C	157	182	232

Double track holder

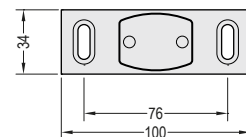

Gelenk für Montagefuß
/ Joint for mounting base

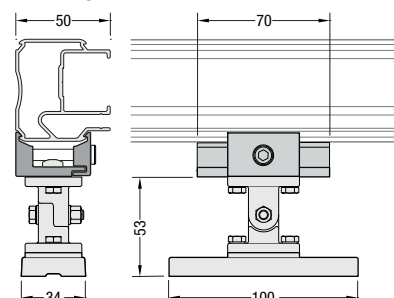

Befestigung / Installation

Ancona Unterglas-Montage / Interior

Schienenhalter

(Standard)

/ Rail holder
(standard)

Montagefuß / Mounting foot

Montagefuß / Mounting foot		8er	10er	13er	18er	VV
A		76	101	126	176	37
B		40	72	97	147	8
C		132	157	182	232	93

Druckplatte

für Montage an
Murano-Glasdach

Pressure plate

for mounting on
Murano glass roof

Druckplatte

ohne Schienenhalter
für Montage an
Murano-Glasdach

**Pressure plate without
rail holder for mounting
on Murano glass roof**

Doppelaufnahme mit Druckplatte

für Montage an
Murano-Glasdach

**Twin mounting with pressure
plate for mounting on
Murano glass roof**

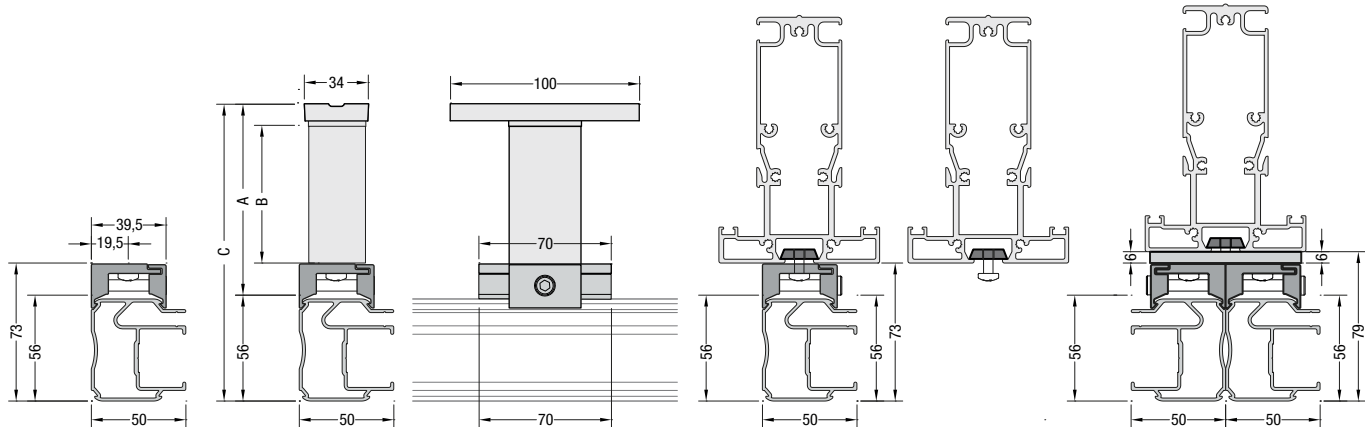

Seitenbefestigung / Lateral attachment

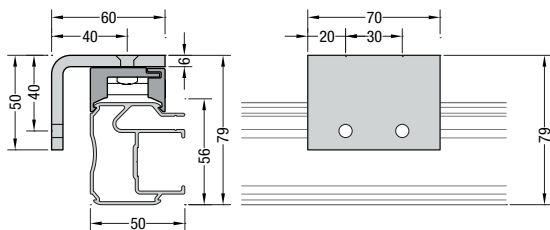

Montageverlängerung / Installation extension

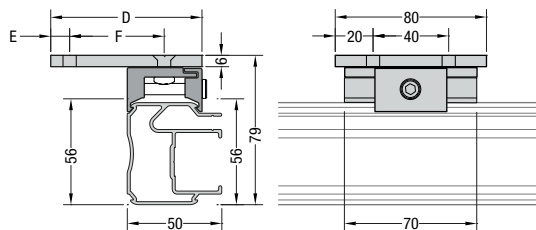

Distanzplatte / Spacer plate

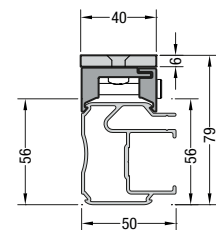

Montageverlängerung / Installation extension

Montageverlängerung		8er	10er
D		80	100
E		20	20
F		40	60

für zweite Führungsschiene
nennenseite bei Montage mit
Seitenbefestigung oder
Montageverlängerung

/ for second guide rail side when
installing with lateral attach-
ment or installation extension

Montageset Seitenverglasung / Lateral glazing assembly set

für die Montage einer Führungsschiene an einem
Außensparren eines Murano-Glasdachs mit Seiten-
verglasung.

/ for mounting a guide rail on an outer rafter of a Murano
glass roof with lateral glazing.

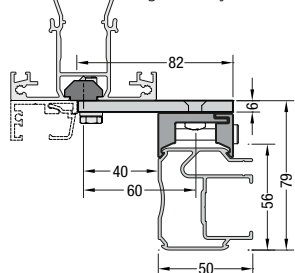

Montagehalter Unterglas / Interior mounting bracket

Halter an der Oberseite der Kassette als Montagehilfe für eine
einfache Montage unter einem Glasdach.

/ Bracket on the top of the cassette as a mounting aid for easy mounting
below a glass roof.

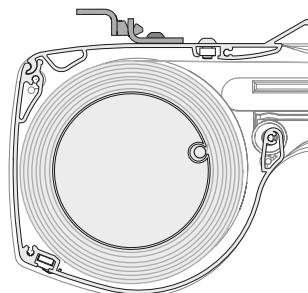

Capri-Montage / fitting

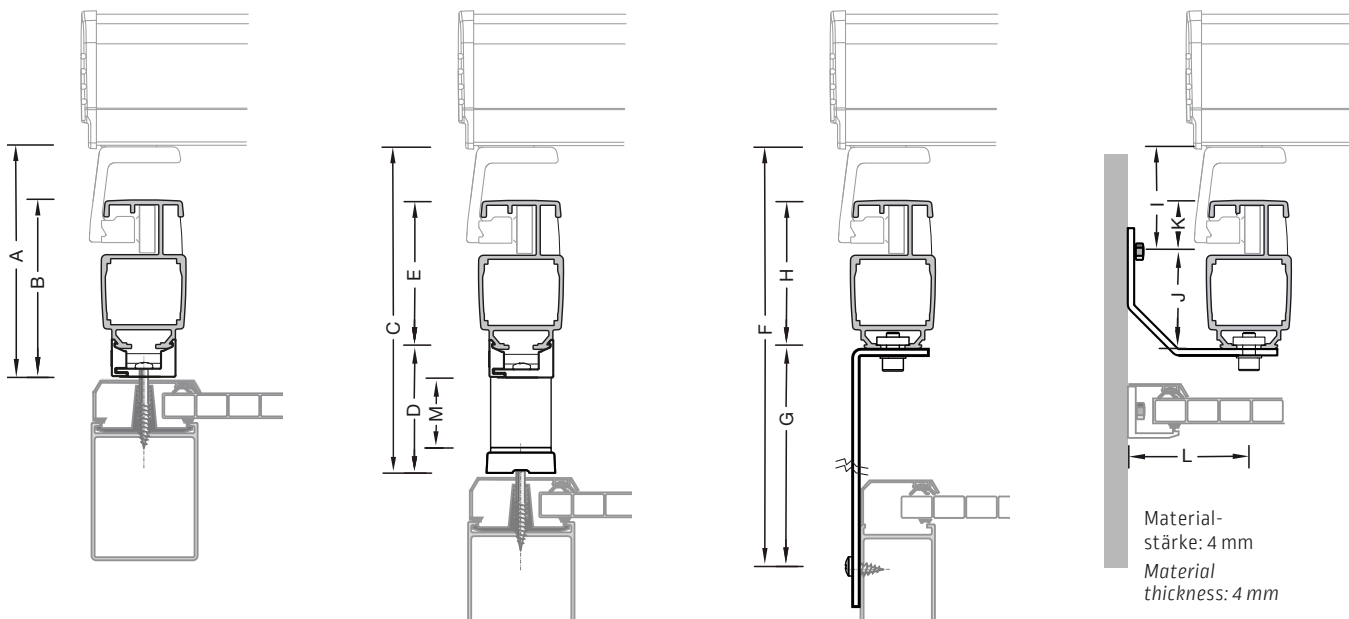

Materialstärke: 4 mm
Material thickness: 4 mm

Schienenhalter / Rail holder	
A	137
B	107

Montagefuß / Mounting foot				
	8 er	10 er	13 er	18 er
C	200	225	250	300
D	76	101	126	176
E	92	92	92	92
M	40	72	97	147

Seitenbefest. / Lateral attachm.			
	47x80	47x120	47x160
F	170	210	250
G	52	92	132
H	92	92	92

Seitenbefestigung Wand / Lateral attachment wall	
I	60
J	65
K	37
L	65

Schienenhalter / Rail holder

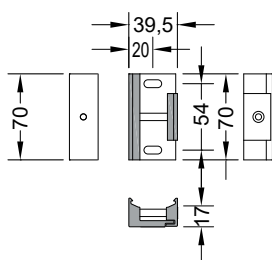

Lochmaße Hole dimensions

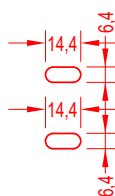

Anzahl Befestigungen / Number of attachments

Breite / Width [cm]	Ausfall / Drop [cm]									
	150	200	250	300	350	400	450	500	550	600
bis 700	4	6	6	6	8	8	8	8	10	10
ab 701	8	12	12	12	16	16	16	16		

Wandhalter

zur Befestigung der Führungsschiene an der Wand
/ Wall bracket for attaching the guide rail to the wall

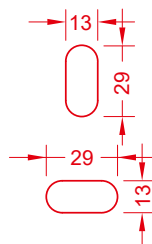
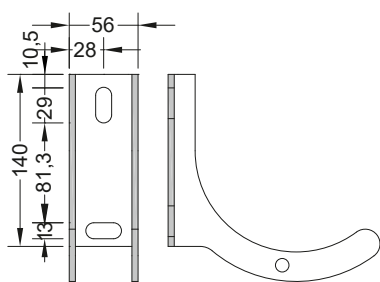

Befestigung / Installation

Micro 700 Wandhalterung/Masten / wall bracket/posts

Wandhalterung
/ Wall bracket

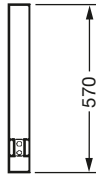

Masten zum Verschrauben am Boden (ggf. kürzbar)
/ Posts for screwing to the base (can be shortened if necessary)

ohne Bodenkonsole
/ without base console



mit Bodenkonsole
/ with base console

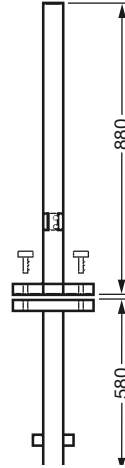

Bodenkonsole
/ Base console

einzel
/ single



Mast, bepulvert in Gestellfarbe (bei silber immer RAL 9006)

Post, powder coated in frame colour (in silver always RAL 9006)

Micro 700 Hinweise / Notes

Der **mögliche Ausfall (Auszug)** ist in Abhängigkeit von der Anlagenhöhe verarbeitungstechnisch begrenzt.

tension (pull-out) depending on the unit height is limited by the manufacturing process.

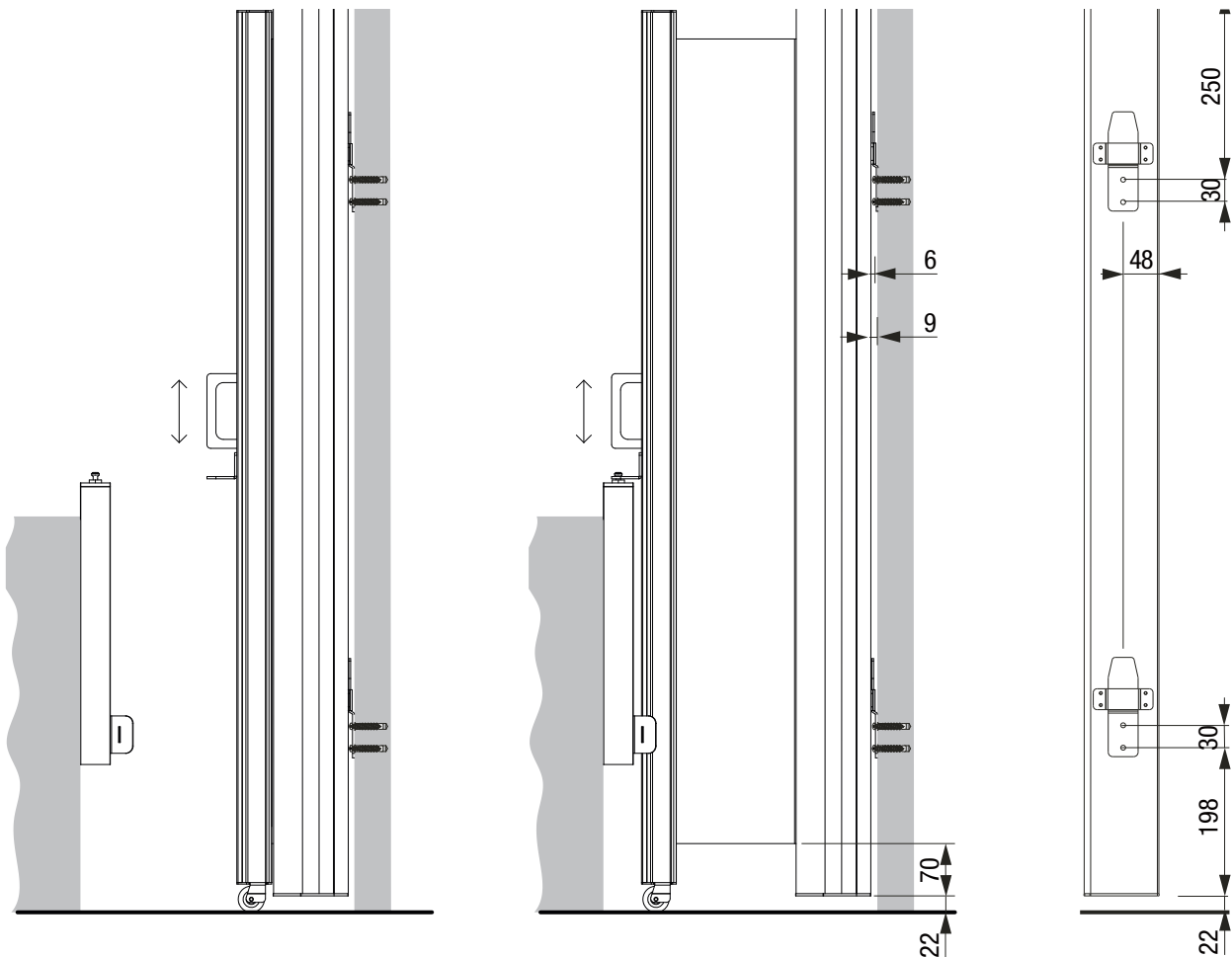

Micro 100 / 300 Konsolen – brackets

Typ / Type

Links / Left

Mitte / Centre

Rechts / Right

Deckenkonsolle / Ceiling bracket

Lochmaße

Hole dimensions

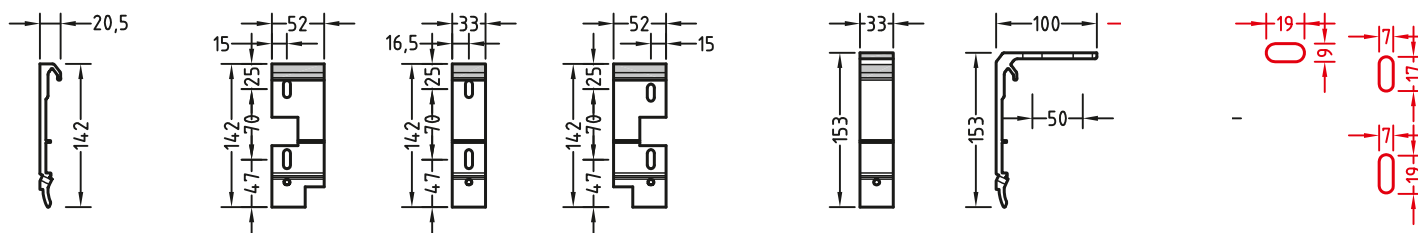

Wandkonsolen und Deckenkonsolle, bepulvert in Gestellfarbe (bei silber immer RAL 9006)
/ Wall brackets and ceiling bracket, powder coated in frame colour (in silver always RAL 9006)

Micro 1060 Seilführung Konsolen / Cable guide – brackets

Typ / Type

Wandkonsolle / Wall bracket

Deckenkonsolle / Ceiling bracket

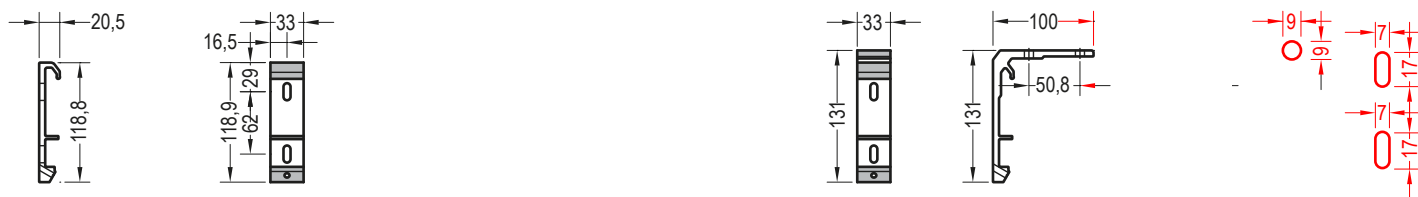

Wandkonsolen und Deckenkonsolle, bepulvert in Gestellfarbe (bei silber immer RAL 9006)
/ Wall brackets and ceiling bracket, powder coated in frame colour (in silver always RAL 9006)

Micro Nischenwinkel / recess angle bracket

Typ / Type

Lagerseite / Bearing side

Getriebeseite / Gear unit side

Lochmaße / Hole dimensions

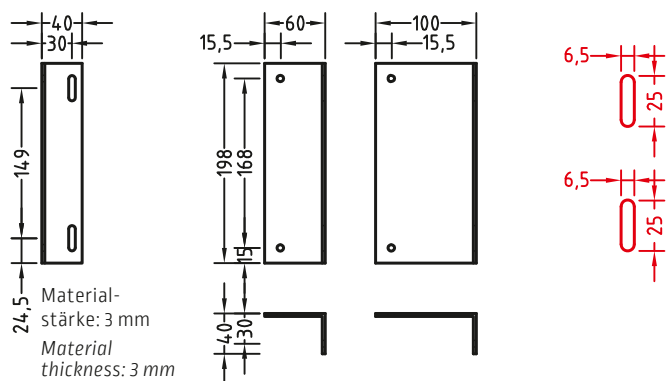

Nischenwinkel für Armhalter, bepulvert in Gestellfarbe (bei silber immer RAL 9006)
/ Recess angle bracket for arm bracket, powder coated in frame colour (in silver always RAL 9006)

Micro 100 / 300 / 1060 Seilführung / Micro 100 / 300 / 1060 Cable guide

Ausgleichsplättchen, Kunststoff / Shim, plastic
1 mm / 3 mm

Befestigung / Installation

Micro 2020 Aufnahmeprofil Wand / Mounting profile – wall

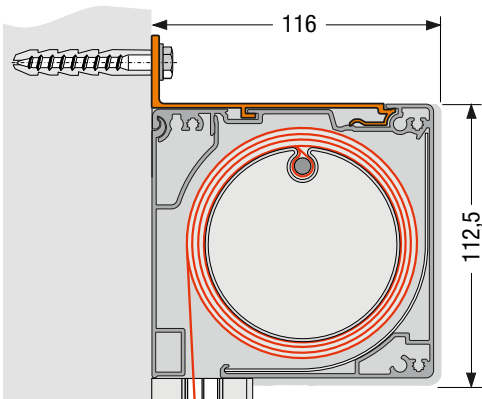

Aufnahmeprofil Decke Mounting profile – ceiling

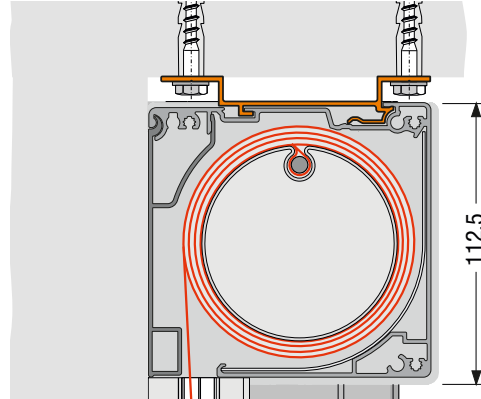

Aufnahmeprofil Wand / Decke, immer in Silber natur Eloxal E6 / EV1
/ Mounting profile – wall / ceiling, always in natural silver, anodized E6 / EV1

Micro 2020 an Murano hinter Rinne / for mounting on Murano, behind gutter

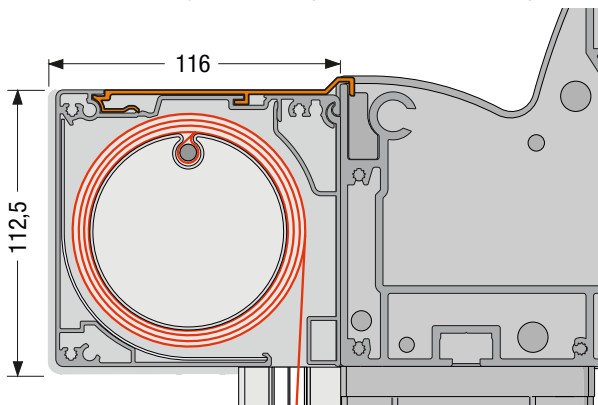

unter Rinne under gutter

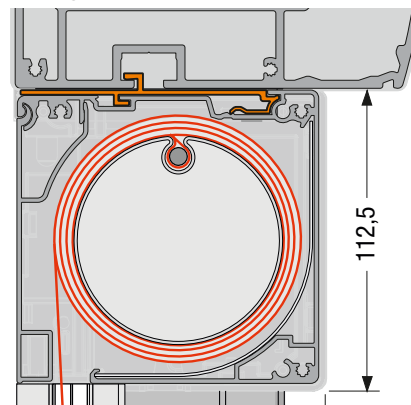

Aufnahmeprofil hinter / unter Murano Rinne, immer in Silber natur Eloxal E6 / EV1
/ Profile for mounting behind / under Murano gutter, always in natural silver, anodized E6 / EV1

Konsolenzahl Micro-Markisen / Number of brackets Micro-awnings

Konsolenzahl für alle Wandmaterialien / Number of brackets for all wall materials

Markisenbreite bis (cm) / Awning width up to	150	200	250	300	350	400	450	500	550	600	650	700
Konsolentyp / bracket type	L/M/R L/C/R	L/M/R L/C/R	L/M/R L/C/R	L/M/R L/C/R	L/M/R L/C/R	L/M/R L/C/R	L/M/R L/C/R	L/M/R L/C/R	L/M/R L/C/R	L/M/R L/C/R	L/M/R L/C/R	L/M/R L/C/R
Micro 100	1/0/1	1/0/1	1/1/1	1/1/1	1/1/1	1/2/1	1/2/1	1/2/1	1/3/1	1/3/1	1/3/1	1/3/1
Micro 300	1/0/1	1/0/1	1/1/1	1/1/1	1/1/1	–	–	–	–	–	–	–
Micro 860 / 1060 / 4000	Befestigung ohne Konsolen: Führungsschienen werden mit Schrauben und Dübeln befestigt. / Installation without brackets: guide rails are attached using screws and plugs.											
Micro 1060 Seilführung / Cable guide	2	2	3	3	3	3	–	–	–	–	–	–
Micro 2020 Aufnahmeprofil Decke / Mounting profile, ceiling	–	–	–	–	–	3	3	4	4	4	–	–
Micro 2020 Aufnahmeprofil Wand / Mounting profile, wall	–	–	–	–	–	1	1	1	1	1	–	–
Micro 2020 an/on Murano hinter oder unter Rinne / behind or under gutter	2	2	2	2	2	3	3	4	4	4	–	–

Konsolenzahl B25 C20/25 Wand

Konsolenzahl für Gelenkarmmarkisen an Beton B25 C20/25 Wandmontage

für die Verwendung mit Dübel zul. Zugkraft 7,6 kN gem. Herstellervorschriften in allen oberen Dübellöchern der Konsolen, z.B. Fischer FAZ II 12.

Number of Brackets B25 C20/25 Wall – for folding arm awnings on concrete B 25 C20/25 wall mounting

for use with anchor bolts, permitted tensile force 7.6 kN as per manufacturer's stipulations in all upper anchor bolt holes on brackets, e.g. Fischer FAZ II 12.

Markisenbreite bis (cm) / Awning width up to	250	300	350	400	450	500	550	600	650	700
Modell / Model	Konsolentyp / Bracket type									
Ausfall bis / Drop up to (cm)	60	60	60	60	60	60	60	60	60	60
Economy	150	2	2	2	2	2	3	3	4	–
	200	2	2	2	2	2	3	3	4	–
	250	–	2	2	2	2	3	3	4	–
	300	–	–	2	2	2	3	3	4	–
Ausfall bis / Drop up to (cm)	90	90	90	90	90	90	180/90	180/90	180/90	180/90
Family Classic Family Design	150	2	2	2	3	3	4	0/4	0/4	0/4
	200	2	2	2	3	3	4	0/4	0/4	0/4
	250	2	2	2	3	3	4	0/4	0/4	0/4
	300	2	2	2	3	3	4	0/4	0/4	0/4
	350	2	2	2	3	3	4	0/4	0/4	2/2
Family Classic + Vario Volant / Vario Valance	150	2	2	2	3	3	4	0/4	0/4	–
	200	2	2	2	3	3	4	0/4	0/4	–
	250	–	2	2	3	3	4	0/4	0/4	–
	300	–	–	2	3	3	4	0/4	0/4	–
Family Compact	150	2	2	2	3	3	4	0/4	0/4	0/4
	200	2	2	2	3	3	4	0/4	0/4	0/4
	250	–	2	2	3	3	4	0/4	0/4	0/4
	300	–	–	2	3	3	4	0/4	0/4	0/4
	350	–	–	–	3	3	4	0/4	0/4	2/2
Ausfall bis / Drop up to (cm)	90	90	90	90	180/90	180/90	180/90	180/90	180/90	180/90
Trentino Mini	150	2	2	2	2	0/2	–	–	–	–
	200	2	2	2	2	0/2	–	–	–	–
	250	–	2	2	2	0/2	–	–	–	–
Trentino	150	2	2	2	3	0/3	0/4	0/4	0/4	0/4
	200	2	2	2	3	0/3	0/4	0/4	0/4	0/4
	250	–	2	2	3	0/3	0/4	0/4	0/4	0/4
	300	–	–	2	3	0/3	0/4	0/4	0/4	0/4
	350	–	–	–	3	0/3	0/4	2/2	2/2	2/2
Trentino + Vario Volant / Vario Valance	150	2	2	2	3	0/3	0/4	0/4	0/4	–
	200	–	2	2	3	0/3	0/4	0/4	0/4	–
	250	–	–	2	3	0/3	0/4	0/4	2/2	–
	300	–	–	–	3	2/1	2/2	2/2	2/2	–
Toscana Mini	150	2	2	2	2	2	–	–	–	–
	200	2	2	2	2	2	–	–	–	–
	250	–	2	2	2	2	–	–	–	–
	150	2	2	2	2	2	2	–	–	–
	200	2	2	2	2	2	2	–	–	–
Toscana	250	–	2	2	2	2	2	–	–	–
	300	–	–	2	2	2	2	–	–	–
	150	2	2	2	2	2	2	–	–	–
Ausfall bis / Drop up to (cm)	90	90	90	90	180/90	180/90	180/90	180/90	180/90	180/90
Toscana Grande	150	2	2	2	2	0/2	0/2	0/2	0/2	0/3
	200	2	2	2	2	0/2	0/2	0/2	0/2	0/3
	250	–	2	2	2	0/2	0/2	0/2	0/2	2/1
	300	–	–	2	2	0/2	0/2	0/2	0/2	2/0
	350	–	–	–	2	0/2	0/2	0/2	2/0	2/0
Toscana Grande + Vario Volant / Vario Valance	400	–	–	–	–	0/2	0/2	2/0	2/0	–
	150	2	2	2	2	0/2	0/2	0/2	0/3	–
	200	–	2	2	2	0/2	0/2	0/2	0/3	–
	250	–	–	2	2	0/2	0/2	0/2	0/3	–
	300	–	–	–	2	0/2	0/2	0/2	2/1	–
350	–	–	–	–	2/0	2/0	–	–	–	